

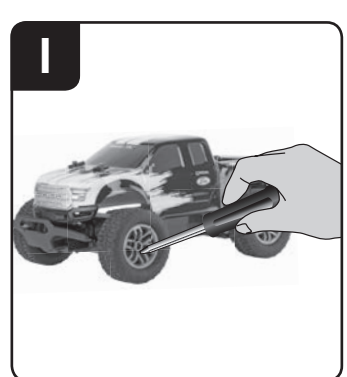

Sicherheitsbestimmungen · Safety instructions
Consignes de sécurité · Disposiciones de seguridad
Norme di sicurezza · Veiligheidsbepalingen
Prescrições de segurança · Säkerhetsbestämmelser
Turvallisuuohjeet · Zasady bezpieczeństwa
Biztonsági rendelkezések · Varnostna določila
Bezpečnostní předpisy · Bezpečnostné predpisy
Sikkerhetsbestemmelser · Sikkerhedsbestemmelser
أنظمة السلامة · Διατάξεις ασφαλείας · 安全准则 · 안전수칙

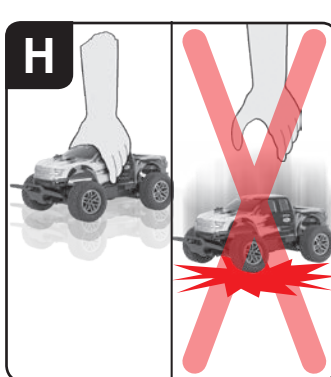
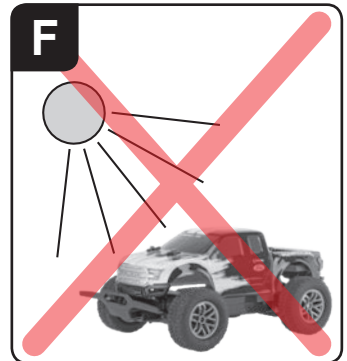
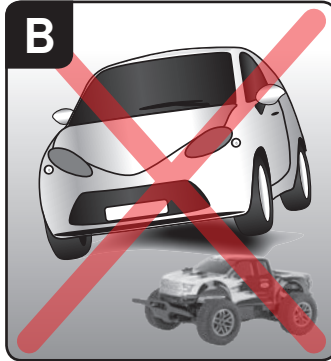

1

**6,4 V 700 mAh!
4,48 Wh LiFePO₄**



**2x 1.5 V Micro AAA batteries
2x Piles 1, 5 V micro AAA
2x Pilas de 1,5 V Micro AAA**



Ford Motor Company Trademarks
and Trade Dress used under
license to Stadlbauer Marketing +
Vertrieb GmbH

2**1**

2 6,4 V 700 mAh!
4,48 Wh LiFePO₄



Green = Connection OK
Vert = Connexion OK
Verde = Conexión OK

LED OFF = Charging
DEL OFF = En charge
LED OFF = Cargando

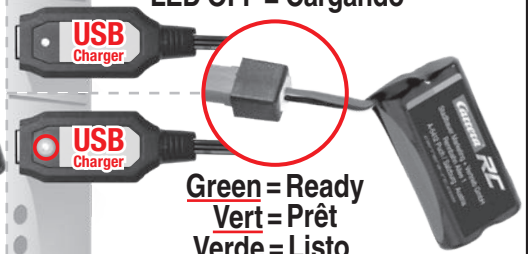

Green = Ready
Vert = Prêt
Verde = Listo

3

**1x 6,4 V 700 mAh!
4,48 Wh LiFePO₄**

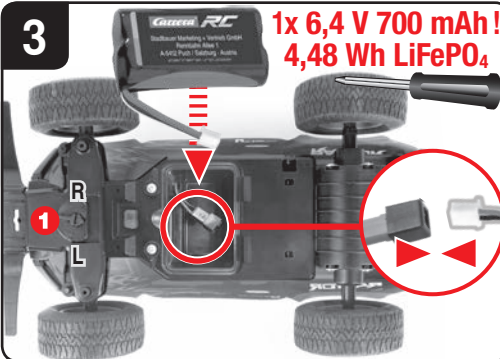
**4**

**2x 1.5 V Micro AAA batteries
2x Piles 1, 5 V micro AAA
2x Pilas de 1,5 V Micro AAA**

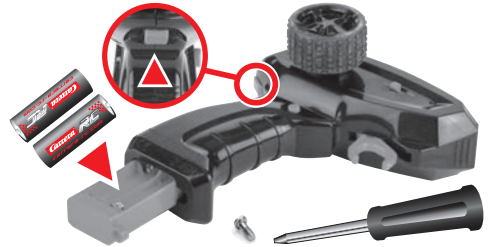
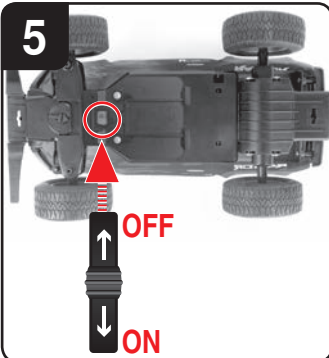
**5****6****7**